

Data Sheet



Article number: 021816011235

Description: Clamp with bracket and rubber
SPGU 6011. 235/30 SK

Measures

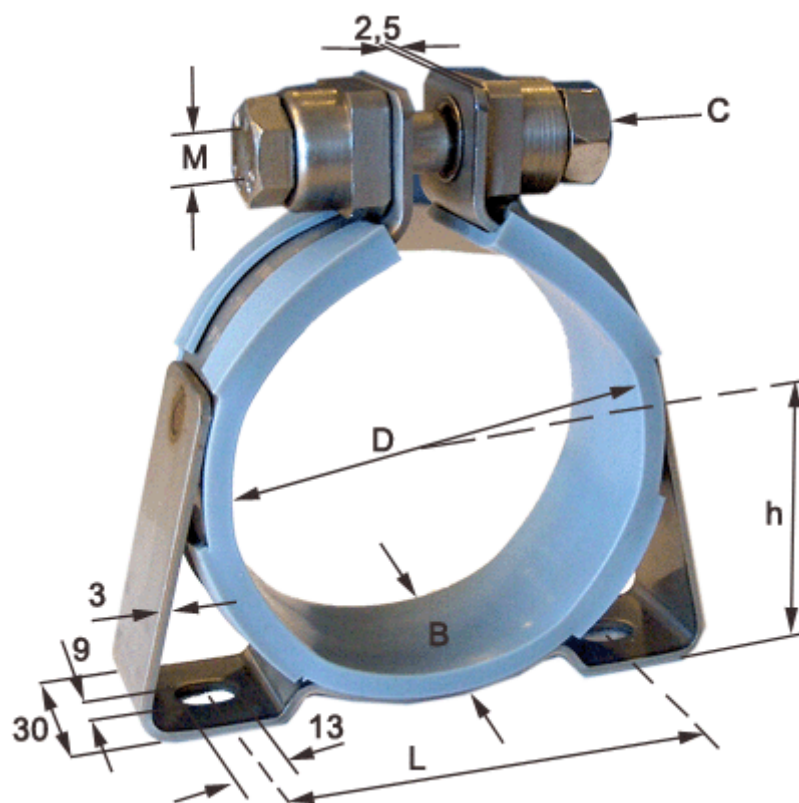

C (screw type) = SK hexagon screw

Diameter D = 235

h = 126

L = 216

Width B = 30